

RACEPAD

CANBUS KEYPAD FOR STEERING WHEEL

RacePad is the ultimate CAN-bus steering wheel button panel designed by Blink Marine to elevate your racing experience to the next level. With 4 rotary knobs and 8 easy-to-reach buttons, RacePad is the perfect addition to any race car. RacePad allows you to fully customize your driving style with individualized button icons and LED colour selection, the possibilities are endless.



SOFTWARE FEATURES

CAN Keypad Addresses – Assign any valid CAN address to the keypad.

CANopen Communications Protocol – Fully compliant with Device Profile 401d.

J1939 Address Claim Transmission – Keypads no longer have to be pre-programmed to a specific address. This enables customers that work in applications in the field without access to a GUI to use any replacement keypad on-hand. The keypad can be configured to automatically announce its address and accept a new address assignment as appropriate.

Event Status Transmission – The keypad can send messages to the BUS indicating a button press or a button release event has occurred. This confirmation allows digital systems to have the same input acknowledgements as that of the latching position of a mechanical switch.

Periodic Status Transmission – The keypad sends a continuous broadcast of messages indicating the press or release status of each button at that instance. The frequency of these messages can be adjusted in a wide range.

Periodic Heartbeat – The keypad sends a continuous broadcast of messages indicating it is functioning correctly. The frequency of these messages can be adjusted in a wide range.

Online Set-up – An online set-up system makes it possible to select and design your own prototype, then order it directly on blinkmarine.com.

STANDARD FEATURES

- Reconfigurable keys
- Replaceable icon inserts
- Configurable LED
- High intensity LED status indicators
- RGB LED Indicators
- LED backlit icons
- Laser etched icons
- Programmable functions (momentary, toggle, scroll...)
- Thousands of stock icons to choose from
- Two different knob types: with or w/o replaceable icon inserts
- Protected from inverted polarity

SOFTWARE FEATURES

- Change CAN keypad addresses independently
- Periodic Status transmission
- Heartbeat
- Event status transmission
- LED acknowledgement
- Address claim transmission
- CANopen and J1939 communication protocol
- Plug-and-play reconfigurability
- Detailed user manuals available

OTHER BENEFITS

- Specific connectors and cables are available on request
- Custom mounting plate
- Pad printed logo

HARDWARE FEATURES

UV Protected – UVB 400 hours: Keypad is highly resistant to deterioration caused by exposure to sunlight.

Customizable Inserts – The replacement system for individual inserts makes modifying the keypad layout simpler and more economical. Thousands of different stock inserts can be viewed at blinkmarine.com, and it is possible to order customized ones.

Independent Key – The device is able to support any multiple pressure key combination.

Encoder With Pushbutton – Use of the knob is both comfortable and immediate. For example, the knob allows its user to manage scroll & select operations without letting go of the handle.

4 additional 5V inputs – Allows the possibility to connect items such as analogue active sensors (such as pressure and temperature sensors), discrete switches (highside/lowside) and Hall Effect sensors.

Independent LED indicator lights – Each rotary encoder has 8 Blue LED light indicators, while all 8 pushbuttons are equipped with RGB LED rings. All LEDs can be independently programmed.

Custom backshell Option



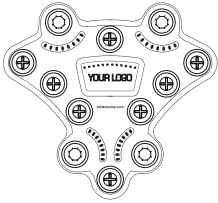

SPECIFICATIONS FOR STANDARD KEYPADS

ELECTRICAL	RACEPAD
Supply Voltage	12-24Vdc Nominal (8-32VDC)
Standby Current	<50 mA
Communication BUS	CANopen, J1939
MTBF	35543 hours (in accordance with MIL-HDBK-217-operating environment ground mobile)
MECHANICAL	RACEPAD
Standard Connector	Deutsch DT04-4P
Inputs Connector	Molex 39-01-3069 (A), Deutsch DTMD4-6P (B)
Switch Life	3 million operations
Rubber Specs	Silicone rubber with polyurethane hardcoat
PCB	1,6mm thick, Nema Grade FR-4, double clad with 1 oz copper
Operating Temperature	-40°C to +70°C
Storage Temperature	-40°C to +85°C
Thermal Shock	-40°C to +85°C According to table 2 of ISO16750-4
UV Protection	UVB 400 hours
Salt Spray	Per ASTM B117
Chemical Resistance	Engine Cleaner, Isopropyl Alcohol, Suntan Lotion, Multi-Purpose Cleaner, Muriatic Acid
Ingress protection Rating	IP54
Weight	300 gr



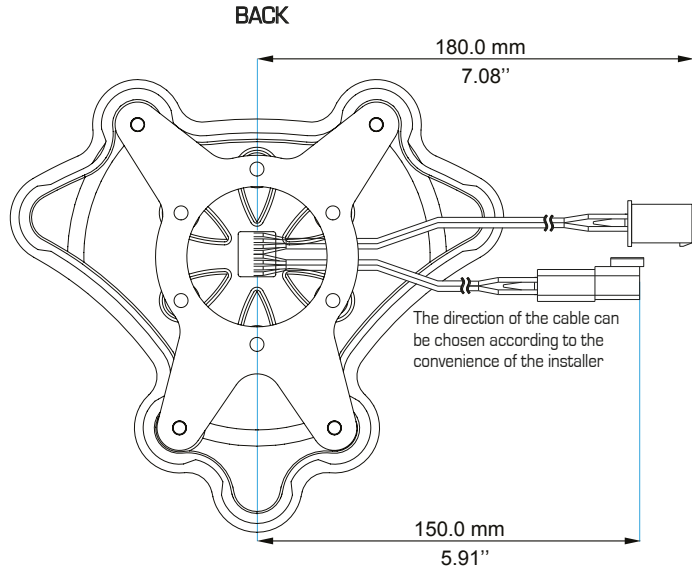
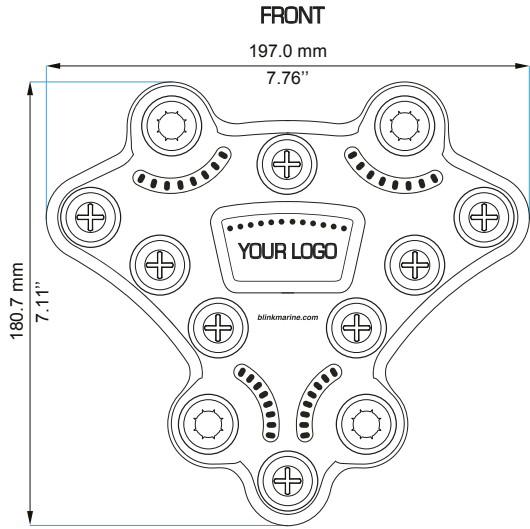

PLASTIC KNOB

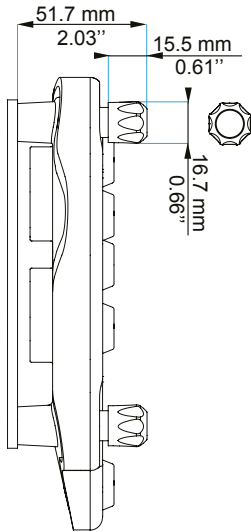

RUBBER KNOB

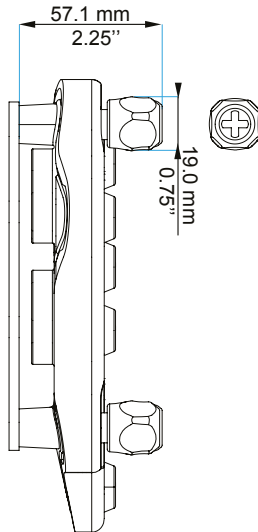

BLACK=GROUND
RED=POWER
WHITE=CAN HIGH
BLUE=CAN LOW

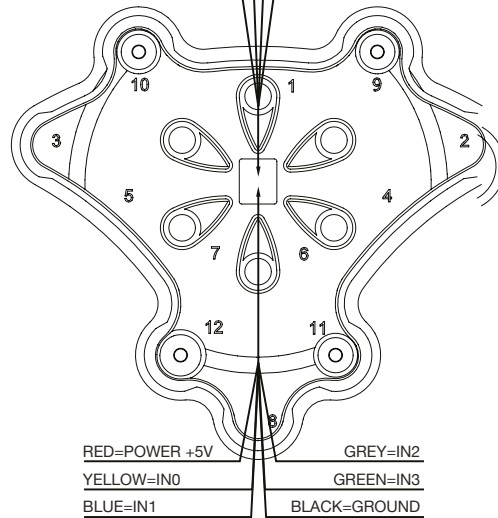

RED=POWER +5V
YELLOW=IN0
BLUE=IN1
GREY=IN2
GREEN=IN3
BLACK=GROUND

MOUNTING NOTES:
Nuts thread: 2x #10-32
Maximum torque: 1,0Nm - 16lbf-in
All connection wires are the same length

**STEERING WHEEL ADAPTER
MOUNT HOLDER**

Included



CONNECTORS STANDARD PINOUT*

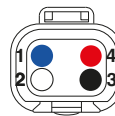

WIRE SIDE

PIN	COLOUR	FUNCTION
1	Blue	CAN L
2	White	CAN H
3	Black	Negative battery
4	Red	Vbatt. (12-24V)



WIRE SIDE

PIN	COLOUR	FUNCTION
1	Red	Power +5V
2	Yellow	IN0
3	Blue	IN1
4	Grey	IN2
5	Green	IN3
6	Black	GND

*The one illustrated above is the standard pinout; however, some keypads may be supplied with alternative pinouts or connectors.



Blink S.r.l.
Via Montefeltro, 6 - 20156 Milano - Italy
Tel. +39 02 3088583 - Fax +39 02 33406697
www.blinkmarine.com - info@blinkgroup.com

!WARNING! IMPROPER SELECTION, IMPROPER USE AND/OR FAILURE OF THE BLINK SYSTEMS PRODUCTS DESCRIBED HEREIN OR RELATED ITEMS CAN CAUSE DEATH, PERSONAL INJURY AND PROPERTY DAMAGE. This document and other information from Blink, provide product and/or system options for further investigation by users having technical expertise. It is important to analyze all aspects of the application, including consequences of any failure. Due to the variety of operating conditions and applications for these product(s), the manufacturer of the application is solely responsible for marking the final selection of the product(s) and assuring that all performance, safety and warning requirements of the application are met. The products described herein, including without limitation, product features, specifications, designs, availability and pricing, are subject to change by Blink at any time without notice.